

DETALLES DE ZAPATAS COLUMNAS DOGS OUT

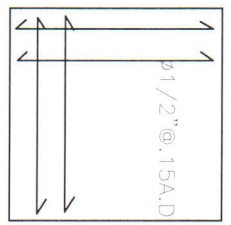

CORTE ZAPATA MB 6"

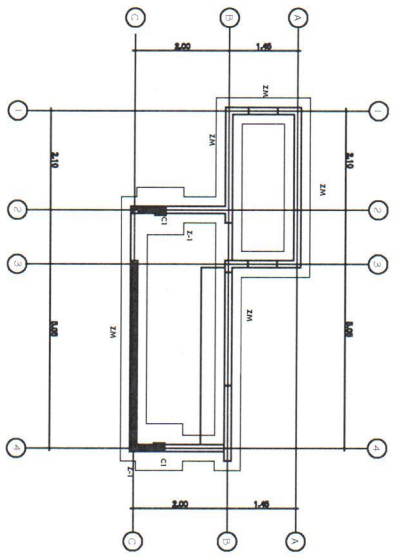
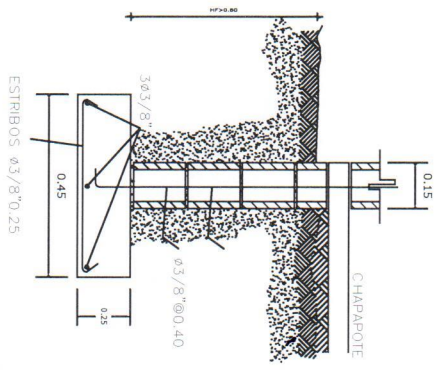

DETALLES DE VIGAS Y DINTELES

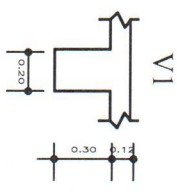
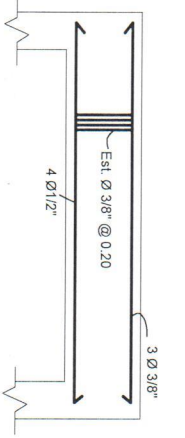

Dinteles 0.15 m x 0.20 m

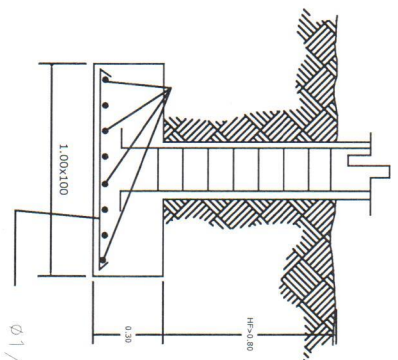
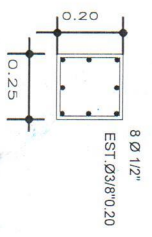

Ø 1/2" @ .15

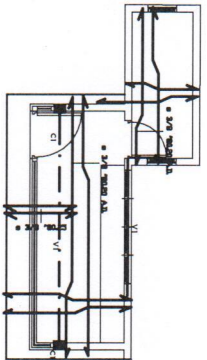

DOGOUT
PLANTA ESTRUCTURAL
1:50

FONPER

INGENIEROS DE PROYECTO DE CONSTRUCCION Y RECONSTRUCCION

Ing. Oscar N. Sandoval, Ing. Alejandro C. Lopez, Ing. Juan Antonio...

PROYECTO	RECONSTRUCCION PLAY BASEBALL CLUB MAMBUICHE
NOMBRE DE HOJA	9 / 16
PLANTA ESTRUCTURAL DOGOUT	
ESCALA	INDICADA

DISEÑO ARQUITECTONICO:	CODIA:
CALCULO ESTRUCTURAL:	CODIA:
DISEÑO ELECTRICO:	CODIA:
DISEÑO SANTARIO:	CODIA:
ESTUDIO GEOTECNICO:	CODIA:
DISEÑO DE PAISAJE:	CODIA:
DIBUJO:	CODIA:

PROPUESTA	FECHA
FIRMA APROBATORIA	
SELLO INSTITUCION	